

760T-36 DURAWALL® Fiberglass Rectangular Shower Wall

Fits Mustee 3660M DURABASE® Shower Floor





Model 760T-36WHT shown with optional 3660M DURABASE® Floor.

760T-36 DURAWALL® Shower Wall features a handsome embossed tile pattern and will create a truly elegant look to your new or remodeled shower.

Features:

- Produced from reinforced, molded fiberglass using matched metal molds.
- Fits 3660M DURABASE®.
- Embossed large-tile pattern, 7-9/16".
- Five-panel wall system with interlocking tongue-and-groove seams for quick assemble, and a watertight seal.
- Mounts direct-to-stud with mounting flanges hidden behind drywall or other wall treatment.
- Smooth white, colorfast gloss finish, resists scuffs.
- Mold and mildew-resistant...easy to clean.
- Available STYLEMATE® By-Pass Shower Enclosures (see reverse side).
- Designed to support CareGiver® Grab Bars and Fold-Down Seats as needed (see reverse side).

Code Accepted: DURAWALL® Fiberglass Shower Walls meet or exceed the applicable performance requirements as listed:

- American Society of Testing and Materials (ASTM) E-84 
- American National Standards Institute (ANSI)–Specification Z 124-2017 

Design Features

Self-aligning side panels with interlocking tongue-and-groove seams



Reverse side of center panel has clips for securing to shower floor



1 1/4" flanges fasten direct-to-studwalls with screws, drywall conceals flanges



572.300 VARISTONE™ Shelf — Optional (see reverse side for details.)

Specifications

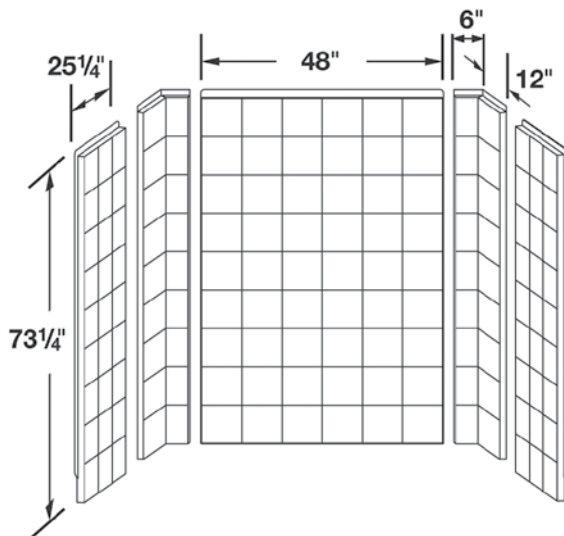

Model	Color
760T-36WHT	White

General: Furnish and install as shown on plans, DURAWALL® Shower Wall Model: 760T-36WHT, as manufactured by E. L. Mustee & Sons, Inc. Shall be semi-gloss 5-piece wall. Panels are molded fiberglass, using matched metal molds under heat and pressure with a minimum uniform thickness of 125 mils and mount direct-to-studwalls. Includes center panel and two corner and side panels. Self-aligning panels using an interlocking tongue-and-groove seam. Shall meet the applicable sections of ANSI Specification Z 124-2017. Color: White.

Companion Products

E.L. Mustee & Sons, Inc. offers a number of products that can be ordered separately to customize your 760T-36 Shower Wall installation

DURABASE® SHOWER FLOORS

Fits the 760T-36 and are sized to replace a standard 36" x 60" bathtub.

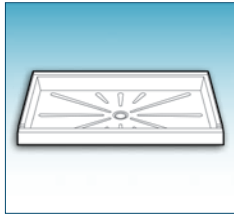

3660 SHOWERTUB® Shower Floor

Model	Drain Location	Color	Size
3660M	Center	White	60" wide x 36" deep

572.300 VARISTONE™ SHELF



Model	Color	Size
572.300	White	12" wide x 7" tall

These self-draining 12" x 7" color-matched shelves, easily mount to the 760T-36WHT shower wall at any location. Order multiple shelves to best meet your personal preference.

CareGiver® Safety Grab Bars

1 1/2" Dia. Straight

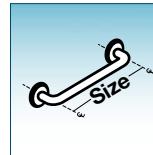

Model No.	Size	Angle
390.305	18"	
390.301	24"	
390.306	36"	
390.307	42"	
390.302	48"	

1 1/2" Dia. Angled

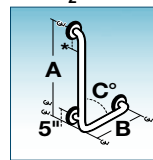

Model No.	A x B	C
390.308, LH	24" x 16"	90°
390.309, LH	32" x 16"	90°

LH= Left Hand

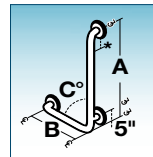

Model No.	A x B	C
390.310, RH	24" x 16"	90°
390.311, RH	32" x 16"	90°

RH= Right Hand

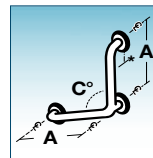

Model No.	A x A	C
390.312	30" x 30"	90°
390.313	12" x 12"	120°
390.314	16" x 16"	120°
390.315	24" x 24"	120°

Rotate for RH or LH use

1 1/2" Dia. Inside-Corner Style

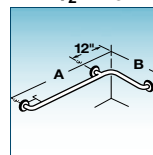

Model No.	A x B	C
390.304	34" x 18"	90°

STYLEMATE® By-Pass Framed & Frameless Enclosures with Tempered Safety Glass



Model	Finish	Model	Finish	Glass	Height	Opening
<i>Framed Design</i>		<i>Frameless Design</i>				
60.403	Bright Silver	60.406	Bright Silver	Clear	69"	59"
60.404	Brushed Nickel	60.407	Brushed Nickel	Clear	69"	59"

CareGiver® Fold-Down Seat



Model 390.413—
23" wide x 14 1/2" deep

The Model 390.413 rectangular wall-mounted seat provides comfortable seating, exceptional design features and long life.

To reorder, specify ADV-527

Notice: Our continuous commitment to product improvement may result in changes to product specifications without notice. Patented and patents pending. ADI/9-19/NM. Made and Printed in U.S.A.